



# HL IB Biology

  
Your notes

## Cell Specialisation

### Contents

- \* Stem Cells
- \* Cell Specialisation
- \* Specialised Cells (HL)
- \* Examples of Specialised Cells (HL)



Your notes

## Stem Cells

### Stem Cell Properties

- A **stem cell** is a cell that can **divide** (by mitosis) an **unlimited number of times**
- Each new cell (produced when a stem cell divides) has the potential to **remain a stem cell** or to develop into a **specialised cell** such as a blood cell or a muscle cell (by a process known as **differentiation**)

### Stem Cell Niches

- After differentiation, a stem cell is **no longer** considered a stem cell
- However, some stem cells do **remain in specific locations** in the human body, this is called the **stem cell niche**
- Their presence **gives the capacity for these tissues to regenerate and repair**
- Some of the tissues which retain stem cells within a niche include
  - **Bone marrow:**
    - Bone marrow provides a niche for stem cells which are used to replace red blood cells, white blood cells and platelets
    - This is important for continual production of these cells which are required indefinitely
  - **Hair follicle:**
    - This niche is located at the root of the hair where the hair is anchored into the skin
    - Stem cells here promote continual hair growth
- The **environment** provided by the niche must have
  - The ability to maintain an **inactive** state of the stem cells
  - The ability to stimulate stem cell **proliferation** and **differentiation**



Your notes

## Stem Cell Potency

- The ability of stem cells to differentiate into more specialised cell types is known as **potency**
- There are four types of potency:
  - **Totipotency** - totipotent stem cells are stem cells that can differentiate into **any cell type found in an embryo, as well as extra-embryonic cells** (the cells that make up the placenta)
    - The zygote formed when a sperm cell fertilises an egg cell is totipotent
    - Also the embryonic cells up to the 16-cell stage of human embryo development are totipotent
  - **Pluripotency** - pluripotent stem cells are embryonic stem cells that can differentiate into **any cell type found in an embryo** but are **not able to differentiate into extra-embryonic cells** (the cells that make up the placenta)
  - **Multipotency** - multipotent stem cells are adult stem cells that can differentiate into closely related cell types
    - For example bone marrow stem cells differentiate into different blood cells
  - **Unipotency** - unipotent stem cells are adult cells that can only differentiate into their **own lineage**
    - For example heart muscle cells (cardiomyocytes) can generate new cardiomyocytes through the cell cycle to build and replace heart muscle. Most cells in animal bodies are unipotent

Stem Cell Potency Diagram

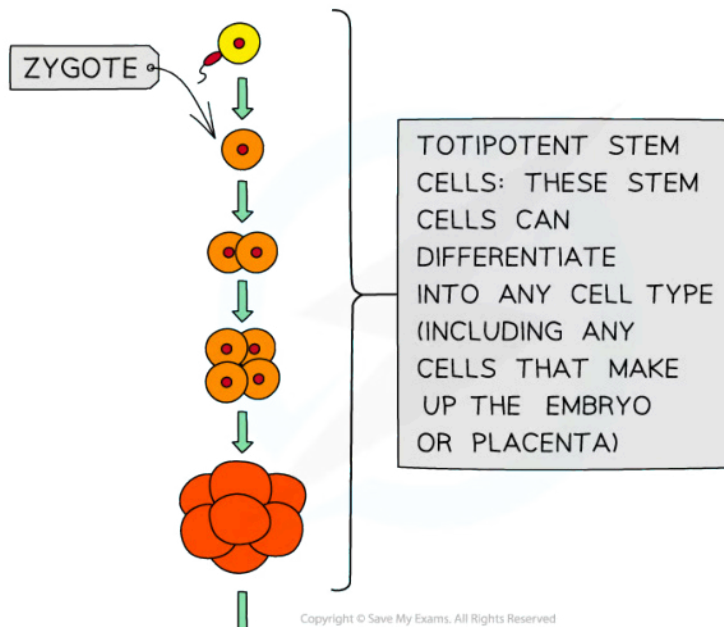



Your notes

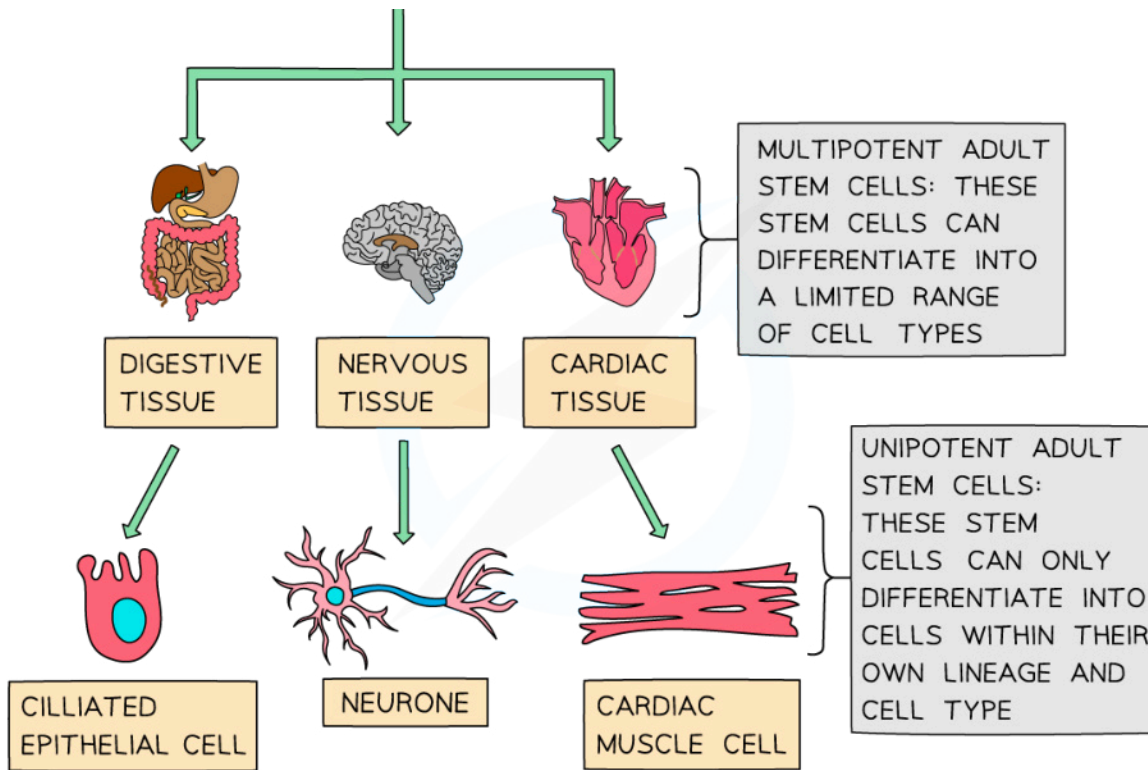

Copyright © Save My Exams. All Rights Reserved

**There are different levels of potency that cells can have. Totipotent cells have the highest potency and can therefore differentiate into any type of cell. Unipotent cells have the lowest potency, only being able to divide into one cell type.**

 **Examiner Tip**

Remember the **two** key properties of stem cells are that they can **self-renew** (capacity to divide) and can **differentiate**. Make sure you learn the levels of potency of stem cells described above, and what range of cell types these stem cells can differentiate into.

Don't forget, while still classed as stem cells (as they can divide any number of times), only a limited range of specialised cells can be formed from adult stem cells as they have already partially differentiated. For example, stem cells in bone marrow can only produce cells that differentiate into the different types of blood cells.

## Cell Specialisation



Your notes

### Development of Specialised Cells

- In complex **multicellular** organisms eukaryotic cells become **specialised** for **specific functions**. This can also be referred to as **the division of labour**
- The process occurs after **fertilisation** to allow development of different tissues within the embryo
- Specialisation enables the cells in these tissues to function more efficiently as they develop specific adaptations for their role. The development of these distinct specialised cells occurs by differentiation
- These specialised eukaryotic cells have **specific adaptations** to help them carry out their functions
- For example, the **structure of a cell** is adapted to help it carry out its function (this is why specialised eukaryotic cells can look extremely **different** from each other)
  - Structural adaptations include:
    - The **shape** of the cell
    - The organelles the cell contains (or doesn't contain)
      - For example: Cells that make large amounts of **proteins** will be adapted for this function by containing **many ribosomes** (the organelle responsible for protein production)



Your notes

## Cell Size & Specialisation

- During the differentiation process, cell sizes can vary drastically
- Size is a feature of adaptation which means that cells require different dimensions to carry out their jobs efficiently

### Cell Specialisation Diagram

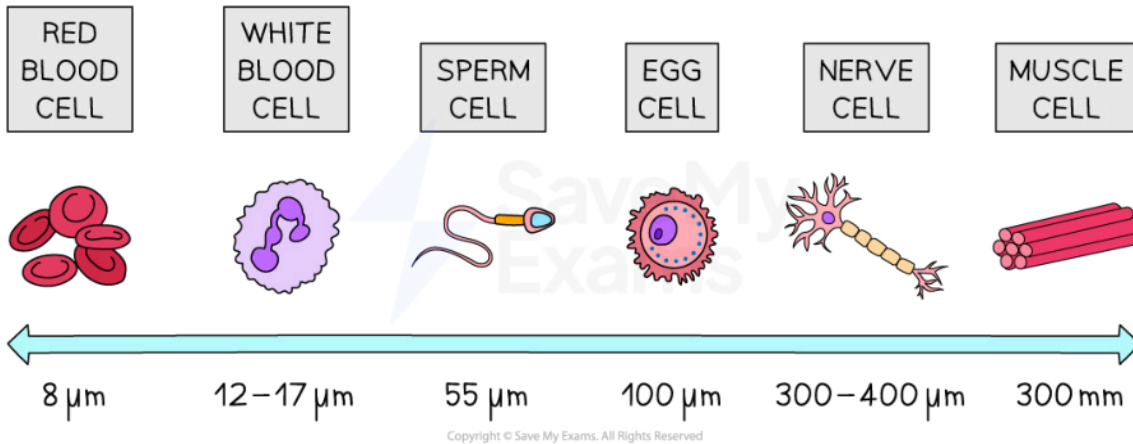

*Cells that have differentiated are specialised cells; they come in all shapes and sizes*

### How differentiation makes cells adapted to their function

- Red blood cells** are small to allow movement through narrow capillaries
- Active white blood cells** are larger than inactive white blood cells to allow space for **rER** and **Golgi apparatus** to allow protein (antibody) synthesis
- Sperm cells** are long to allow for **movement** towards the egg cell, they also have narrow **streamlined** heads to **reduce resistance** to reaching the egg cell
- An **egg cell** body has the **largest volume** of all cells to allow for stored food reserves.
- A **nerve cell** has a **large cell body** to allow for **protein synthesis** to maintain the structure of the **long axon** which is required for rapid delivery of **impulses** around the nervous system
- Muscle cells** are larger than normal cells, length and diameter is designed to exert **force during muscle contraction**



Your notes

## Constraints on Cell Size

### Surface area to volume ratio

- For cells to survive, metabolic reactions must be occurring; these reactions rely on materials being constantly **exchanged** across the plasma membrane at the cell's **surface**
- The metabolic requirements of a cell will vary depending on the **volume** or mass of cytoplasm (as this is where the reactions take place); a cell with a **larger volume will have higher metabolic requirements**, and vice versa
- As cells increase in size their **surface area to volume ratio (SA:V)** decreases as there is **less surface area in relation to the volume** of the organism
- So, an increase in volume will increase a cell's metabolic requirements, but its ability to carry out exchange with its environment **does not increase at the same rate**

### Constraints on cell size

- Single-celled organisms have a **high SA:V ratio**; this means that they can survive by exchanging substances with their environment by **simple diffusion at the cell surface**
  - Their **metabolic requirements** are relatively **low**
  - The surface area is large enough to allow for sufficient absorption of **nutrients** and **gases** and secretion of **waste products**
  - The small volume means the **diffusion distance to all organelles is short**
- SA:V ratio decreases as cells get larger; this means that cells **cannot grow bigger indefinitely**; for larger cells the **SA:V ratio is too small** for cells to survive using only diffusion at the cell surface
  - Their metabolic requirements are **higher**
  - The surface area does not increase at the same rate as the metabolic requirements, so is **not large enough** to allow for a sufficiently high rate of exchange with the environment
  - The large volume means that the **diffusion distance to the centre of the cell is long**, so substances cannot diffuse quickly enough across the cell to reach the organelles where they are needed
- This means that once the SA:V ratio becomes too small, growth must stop and the cells must divide, giving rise to multicellular organisms
- Multicellular organisms have **evolved adaptations** to facilitate:
  - The exchange of substances between their internal tissues and the external environment, e.g.
    - Gas exchange systems
    - Digestive systems
  - Efficient transport of substances within their bodies
    - Circulatory systems

### Surface area to volume ratio diagram



Your notes

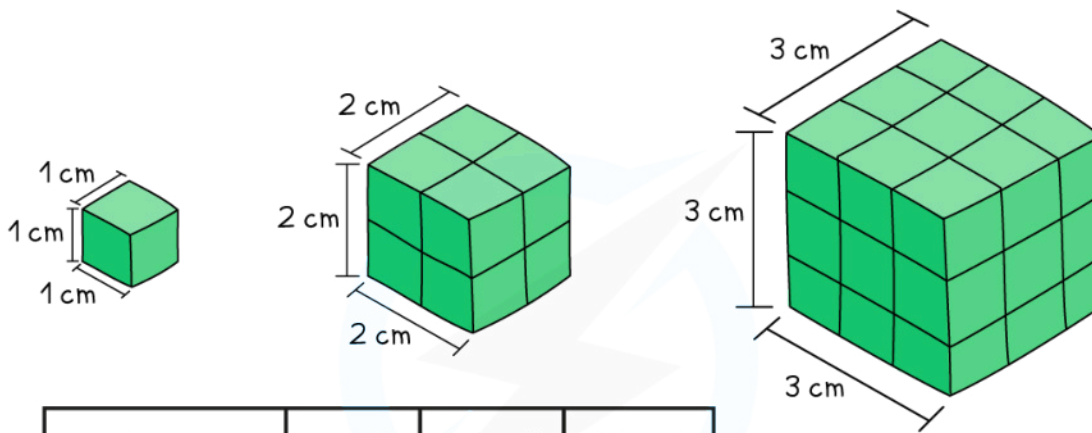

Surface area	6 cm <sup>2</sup>	24 cm <sup>2</sup>	54 cm <sup>2</sup>
Volume	1 cm <sup>3</sup>	8 cm <sup>3</sup>	27 cm <sup>3</sup>
Surface area: volume	6:1	3:1	2:1

Copyright © Save My Exams. All Rights Reserved

*As the size of an organism increases, its surface area : volume ratio decreases; this means that as it gets larger, it becomes more difficult for an organism to gain enough oxygen and nutrients at its cell surface, as its requirements will increase faster than the available surface for diffusion*

### Examiner Tip

Remember that the rate of metabolism is dependent on the mass or volume of the cell, whereas the rate of exchange is dependent on the surface area.

## NOS: Students should recognise that models are simplified versions of complex systems

- Scientists use **models** to represent real world ideas, organisms, processes and systems that cannot be easily investigated
- Scientists can **experiment** on the models enabling them to **test predictions** and develop **explanations** for observations made
- The investigation below uses **agar cubes** to model the effect of changing surface-area-to-volume ratio on the rate of ion **diffusion**
- Although the cubes do not perfectly represent the shapes of real organisms, the **scale factors** and the resulting affect on diffusion still applies

## Method



- **Coloured agar is made up and cut into cubes** of the required dimensions (eg. 0.5cm x 0.5cm x 0.5cm, 1cm x 1cm x 1cm and 2cm x 2cm x 2cm)
  - Purple agar can be created if it is made up with very dilute sodium hydroxide solution and Universal Indicator
  - Alternatively, the agar can be made up with Universal Indicator only
- The **surface area, volume and surface area to volume ratio of these cubes is calculated** and recorded
- The cubes are then **placed into boiling tubes containing a diffusion solution** (such as dilute hydrochloric acid)
  - The same volume of dilute hydrochloric acid should be carefully measured out into each boiling tube
  - The acid should have higher molarity than the sodium hydroxide so that its diffusion can be monitored by a change in colour of the indicator in the agar blocks
- Measurements can be taken of either:
  - The time taken for the acid to completely change the colour of the indicator in the agar blocks
  - The distance travelled into the block by the acid (shown by the change in colour of the indicator) in a given time (e.g. 5 minutes)



Your notes

INVESTIGATING SA WITH AGAR METHOD

1 CUT COLOURED AGAR INTO CUBES OF REQUIRED DIMENSIONS

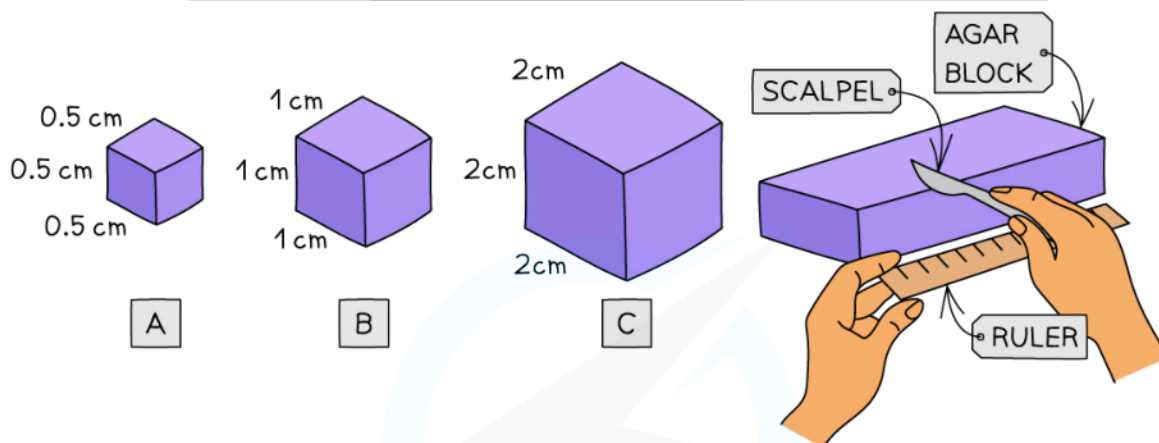

2 CALCULATE SURFACE AREA, VOLUME, AND SURFACE AREA: VOLUME RATIO OF EACH CUBE

Cube	SA (cm <sup>2</sup> )	Vol (cm <sup>3</sup> )	SA : Vol
A	1.5	0.125	12 : 1
B	6	1	6 : 1
C	24	8	3 : 1

Copyright © Save My Exams. All Rights Reserved

3

PLACE AGAR CUBES INTO BOILING TUBES CONTAINING THE DIFFUSION SOLUTION

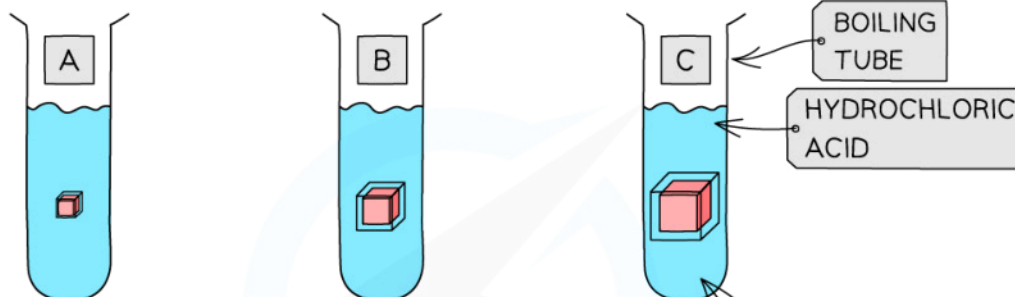

AS THE HYDROCHLORIC ACID DIFFUSES INTO THE AGAR CUBE, THE COLOUR OF THE INDICATOR CHANGES (IN THIS CASE IT GOES COLOURLESS)

4

MEASURE THE TIME TAKEN FOR THE AGAR CUBES TO GO COLOURLESS

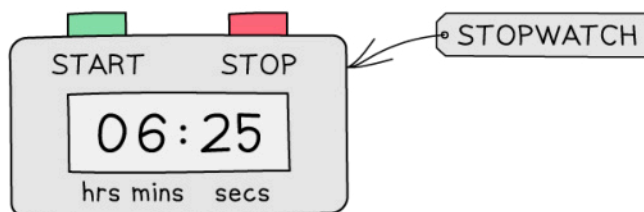

Copyright © Save My Exams. All Rights Reserved

**The steps used to investigate the effect of changing the surface area to volume ratio on diffusion**

### Analysis

- If the time taken for the acid to completely change the colour of the indicator in the agar blocks is recorded, these times can be converted to rates
- A graph could be drawn showing how the rate of diffusion (rate of colour change) changes with the surface area : volume ratio of the agar cubes

INVESTIGATING SA WITH AGAR ANALYSIS

1 CALCULATE THE RATE OF DIFFUSION IN EACH AGAR CUBES

Cube	SA (cm <sup>2</sup> )	Vol (cm <sup>3</sup> )	SA : Vol	Time (s) (seconds)	Rate (s <sup>-1</sup> ) (1/Time)
A	1.5	0.125	12 : 1	176	0.0057
B	6	1	6 : 1	259	0.0039
C	24	8	3 : 1	384	?

TIME TAKEN FOR AGAR CUBES TO GO COLOURLESS

$$\begin{aligned} \text{RATE} &= \frac{1}{\text{TIME TAKEN}} \\ &= \frac{1}{384 \text{ s}} \\ &= 0.0026 \text{ s}^{-1} \end{aligned}$$

2 PLOT A GRAPH FOR RATE OF DIFFUSION AGAINST SURFACE AREA : VOLUME RATIO

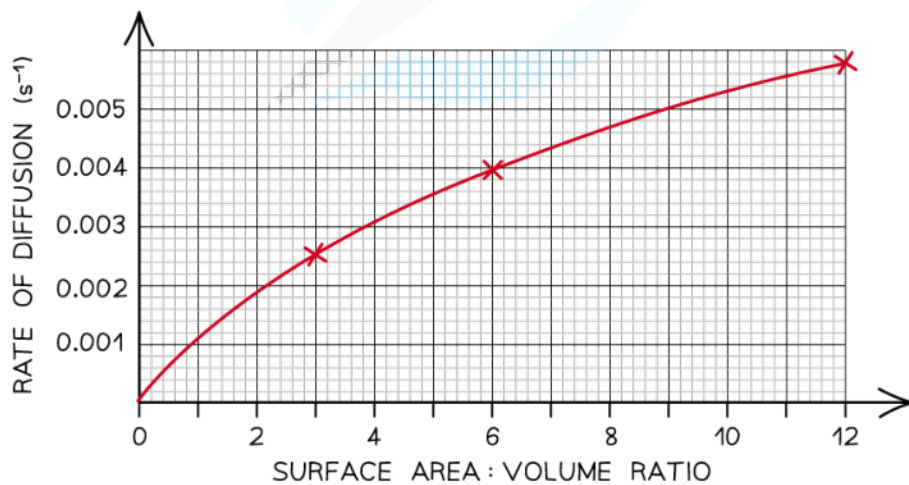

Copyright © Save My Exams. All Rights Reserved

3 USE THE GRAPH TO WRITE A CONCLUSION

AS THE SURFACE AREA TO VOLUME RATIO OF THE AGAR CUBE INCREASES, THE RATE OF DIFFUSION THROUGH THE AGAR CUBE ALSO INCREASES. FOR EXAMPLE, CUBE C ( $2\text{cm} \times 2\text{cm} \times 2\text{cm}$ ) HAD THE SMALLEST SURFACE AREA TO VOLUME RATIO (3:1) AND A RATE OF DIFFUSION OF  $0.0026\text{ s}^{-1}$ , WHEREAS CUBE A ( $0.5\text{cm} \times 0.5\text{cm} \times 0.5\text{cm}$ ) HAD THE LARGEST SURFACE AREA TO VOLUME RATIO (12:1) AND RATE OF DIFFUSION OF  $0.0057\text{ s}^{-1}$ .

Copyright © Save My Exams. All Rights Reserved



Your notes

*To analyse the results of the investigation, calculate the rates of diffusion before drawing a graph for rate of diffusion against surface area : volume ratio*



Your notes

## Specialised Cells (HL)

### Increasing Surface Area : Volume

- It is crucial to maximise surface area to volume ratio in cells which require movement of substances across the membrane
- The larger the surface area compared to the volume of the cell, the faster the rate of substance movement

### Red blood cells

- The function of a red blood cell (also known as an erythrocyte) is to deliver oxygen from the lungs to respiring cells
- They are **flattened and biconcave shaped** in order to maximise the surface area and minimise volume
- This means that oxygen can diffuse into the red blood cell more quickly in the lungs and out again at the respiring tissues

#### Adaptations of a Red Blood Cell Diagram

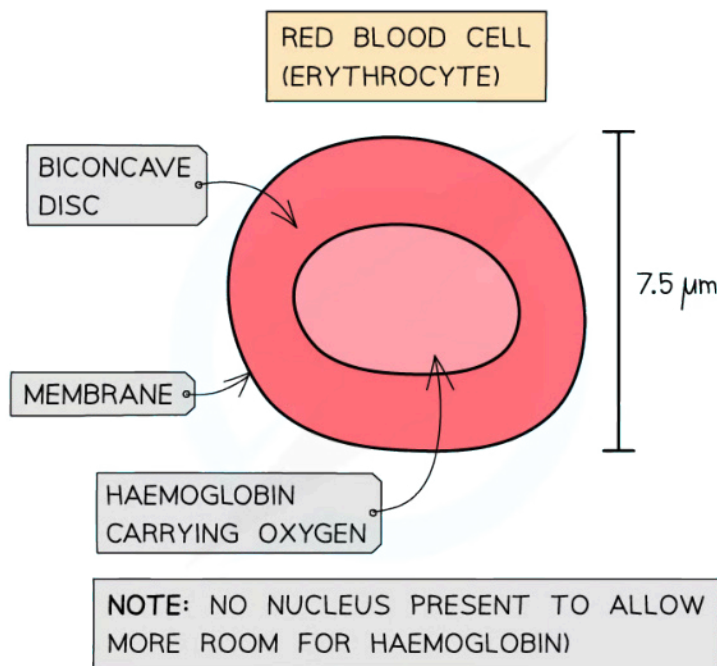

Copyright © Save My Exams. All Rights Reserved

*The biconcave shape and flattening of erythrocytes increases the surface area available for oxygen absorption*

### Proximal convoluted tubule cells

- The proximal convoluted tubules are tiny tubes found in the outer region of the kidney



Your notes

- The tubules are responsible for reabsorption of vital substances e.g. glucose and mineral ions from the glomerular filtrate
- There are several adaptations to maximise surface area in the proximal convoluted tubule cells to ensure that the body reabsorb all the necessary substances
  - **Microvilli** - in the apical membrane
  - **Invaginations** - infoldings found in the basal membrane

**Proximal Convoluted Tubule Cell Adaptations Diagram**

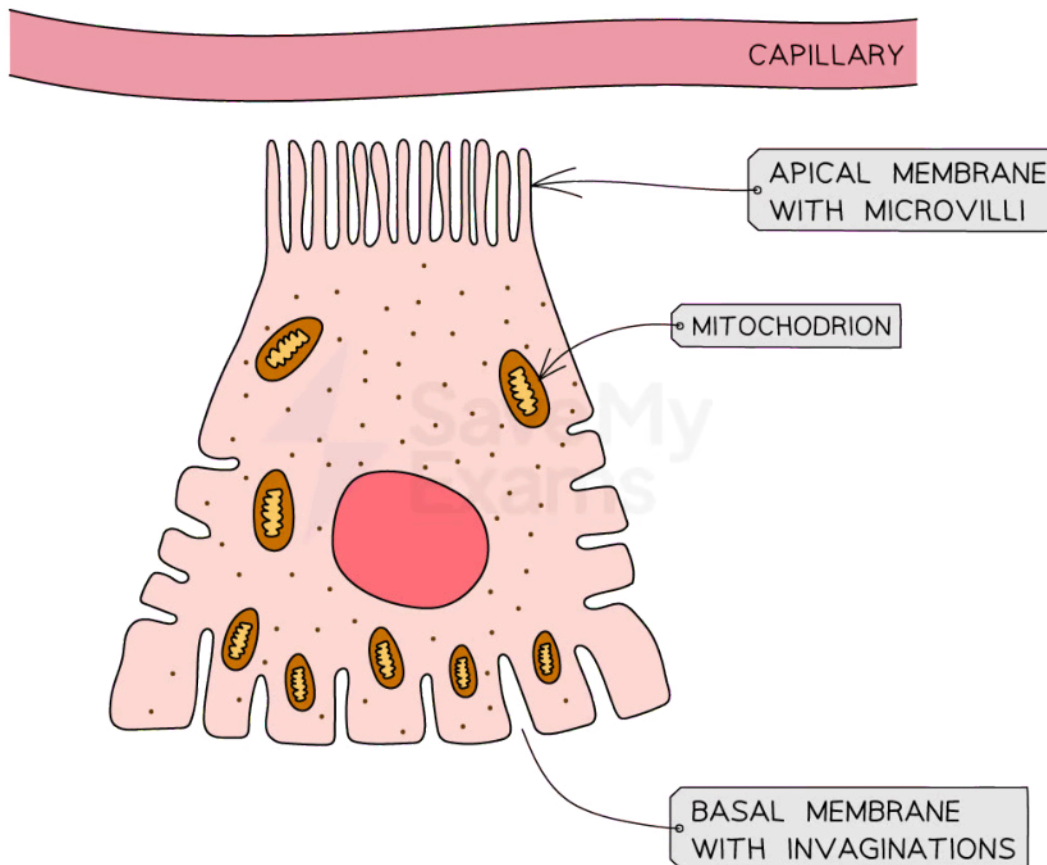

Copyright © Save My Exams. All Rights Reserved

**The cells of the proximal convoluted tubule cells have invaginations and microvilli to increase surface area**



Your notes

## Examples of Specialised Cells (HL)

### Pneumocyte Adaptations

- There are millions of **alveoli** in the lungs which collectively provide **maximum surface area** for gas exchange by **diffusion**
- In addition to this, the alveolar walls (also called **alveolar epithelium**) are only one cell thick which provides a **short diffusion distance**
- Two** different cell types make up the tissue of the alveolar epithelium

### Type I Pneumocytes

- Type I pneumocytes** are extremely **thin alveolar cells** which make up the majority of the alveolar epithelium
  - They are adapted to maximise the rate of gas exchange by providing a **short diffusion distance**
  - The capillary walls are also only **one cell thick** which means there is usually less than **0.5 μm** between the air in the alveoli and the blood, this **maximises the rate of diffusion**

### Structure and Adaptations of Type I Pneumocytes Diagram

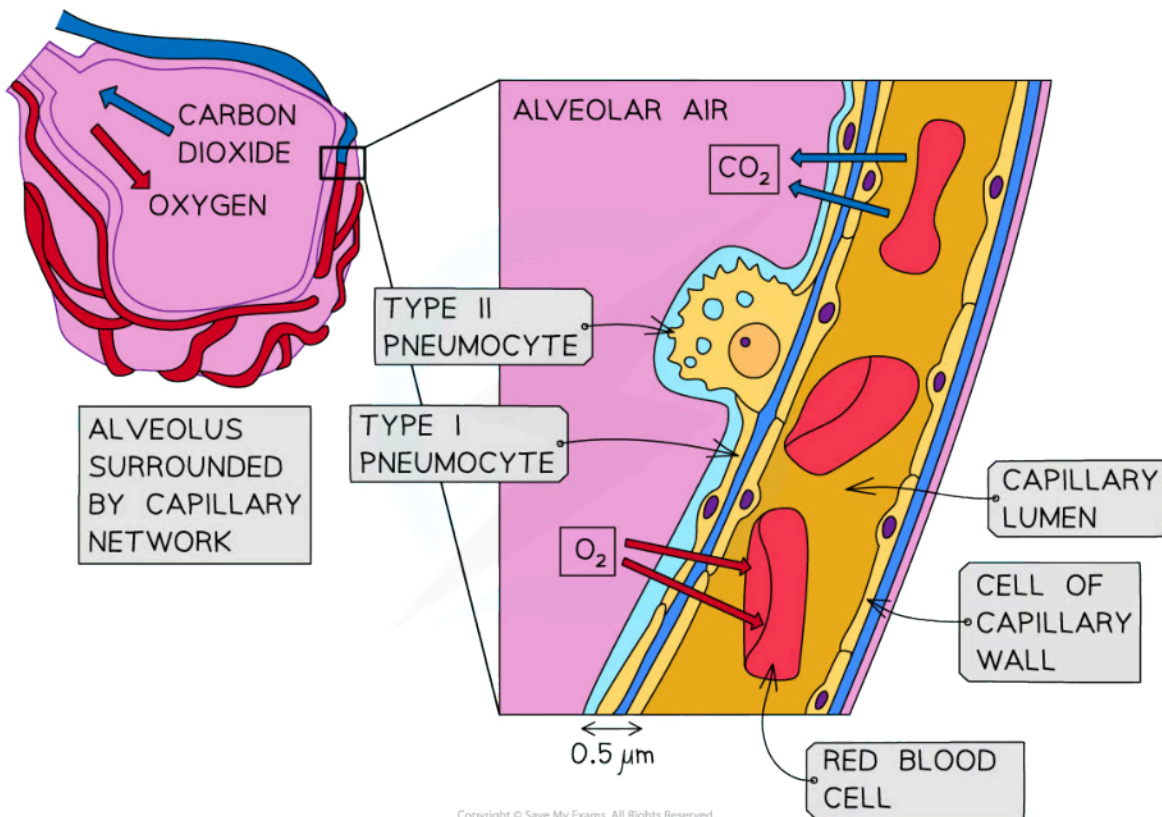



*The thin type I pneumocyte cells and the thin capillary walls provide a short diffusion distance to maximise gas exchange*



Your notes

## Type II Pneumocytes

- Type II pneumocytes are **rounded cells** which possess many **secretory vesicles** (lamellar bodies) which secrete a solution that coats the epithelium of the alveoli
- They occupy a much smaller proportion of the alveolar epithelium than the type I pneumocytes, around 5%
- The solution released by type II pneumocytes contains **pulmonary surfactant**
  - Pulmonary surfactant has hydrophobic **tails** and hydrophilic **heads**
  - The molecules form a monolayer with the hydrophobic tails facing the alveolar air
- Pulmonary surfactant **reduces** surface tension, maintaining alveolar **shape** and **preventing the alveoli sacs sticking** together
  - This prevents the alveoli, and therefore the lungs, from **collapsing**
- The solution also aids gas exchange
  - The layer of moisture provided by the solution allows **oxygen to dissolve** before it diffuses into the blood
  - Carbon dioxide** diffuses from the moist surface before it is removed in exhalation

### Arrangement of Pulmonary Surfactant Produced by Type II Pneumocytes Diagram

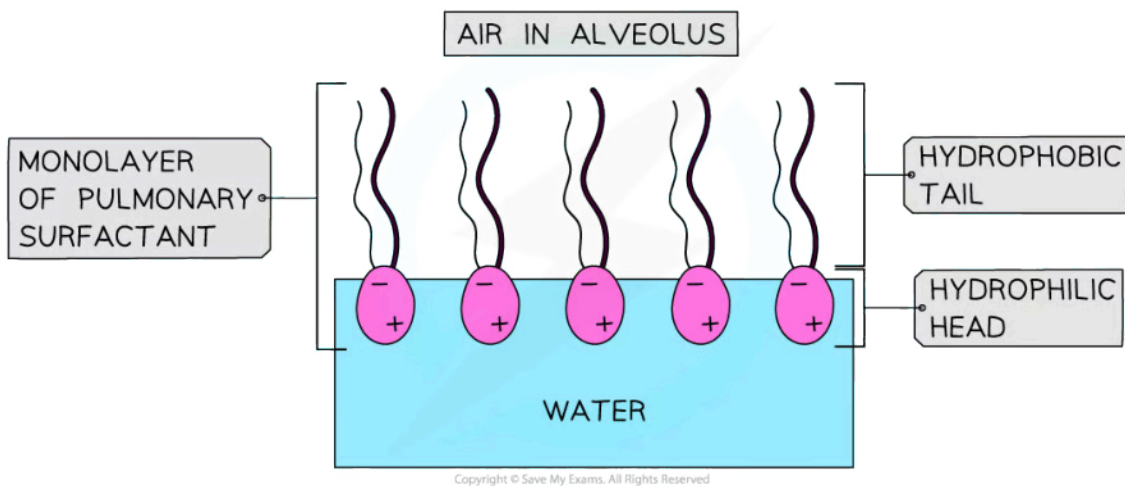

*The type II pneumocyte cells in the alveoli produce a solution containing pulmonary surfactant which reduces surface tension*

### Type I and Type II Pneumocytes Diagram



Your notes

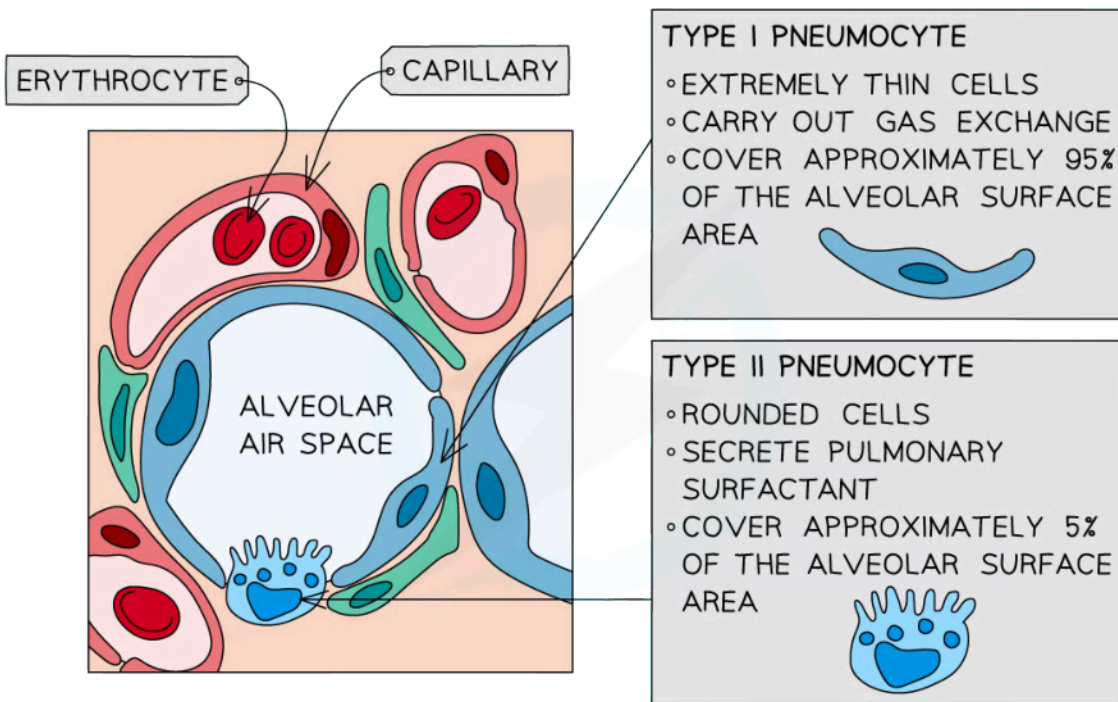

**The alveolar epithelium is made up of type I and type II pneumocyte cells**

## Cardiac & Striated Muscle Adaptations

- Muscles in the body that are attached to the skeleton and aid movement are called **skeletal muscles**
- Other muscle types include:
  - **Cardiac muscle** which is found in the heart
  - **Smooth muscle** is found in the blood vessels and organs

### Striated Muscle Fibres

- Skeletal muscle is **striated** as it has a stripy appearance when viewed under a microscope
- Striated muscle cells are bundled up into fibres which are surrounded by a single plasma membrane called the **sarcolemma**
- The fibres are highly specialised **cell-like** units
- Fibres are referred to as being cell-like due to features which distinguish their ultrastructure from that of other more traditional cells
  - Each muscle fibre contains:
    - An organised arrangement of **contractile proteins** in the cytoplasm
    - **Many nuclei** – this is why muscle fibres are not usually referred to as cells
    - Specialised endoplasmic reticulum called the **sarcoplasmic reticulum** (SR) which stores calcium and conveys signals to all parts of the fibre at once using protein pumps in the membranes
    - Specialised cytoplasm called the **sarcoplasm** contains **mitochondria** and **myofibrils**
      - The mitochondria carry out **aerobic respiration** to generate the ATP required for muscle contraction
      - Myofibrils are bundles of **actin and myosin filaments**, which slide past each other during muscle contraction
- The **sarcolemma** (muscle fibre membrane) has many deep tube-like projections that fold in from its outer surface
  - These are known as **transverse system tubules** or **T-tubules**
  - These run close to the SR

### Diagram to show the Structure of Striated Muscle Fibres



Your notes



Your notes

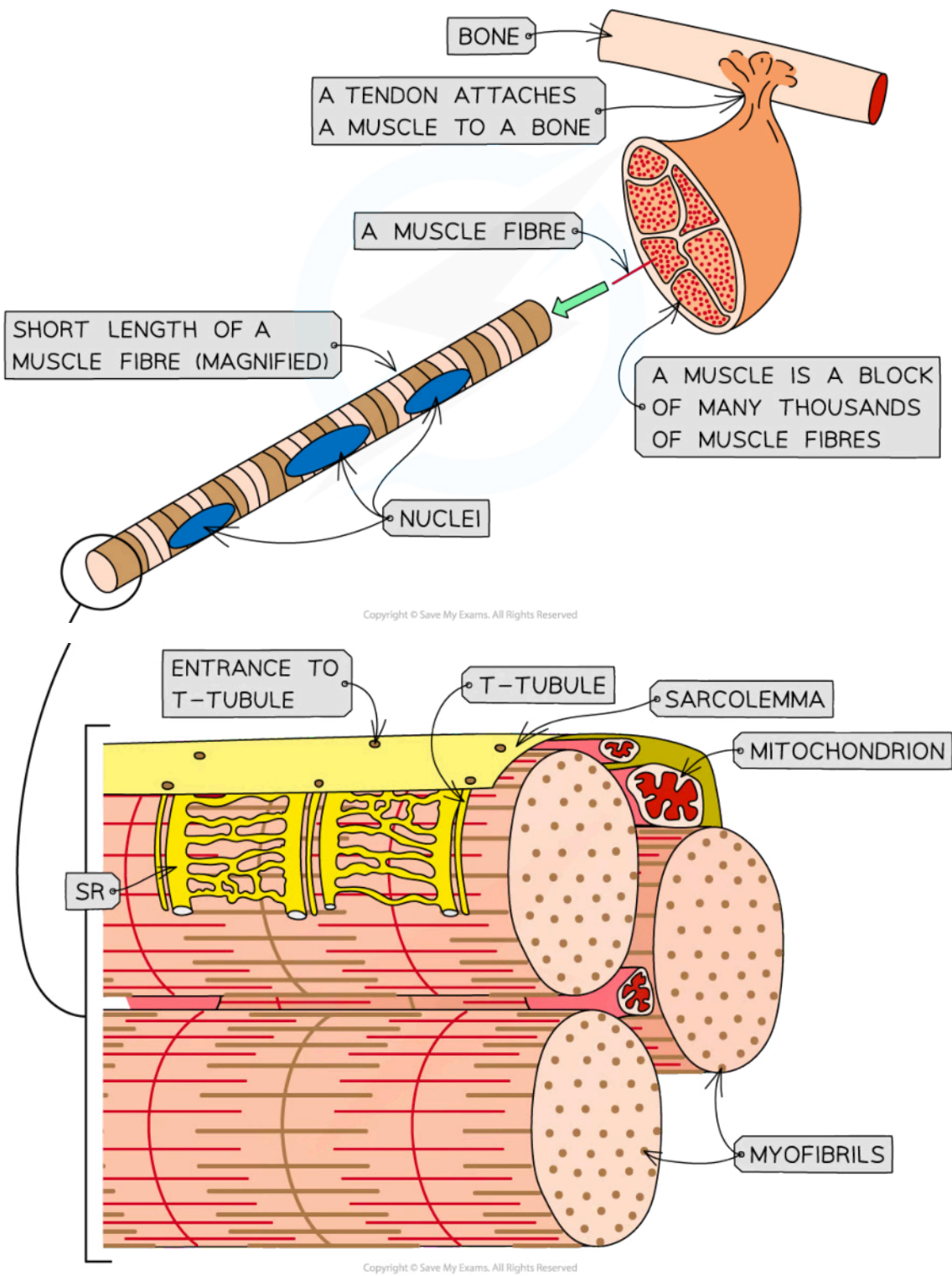

The ultrastructure of striated muscle and of a section of muscle fibre



Your notes

## Cardiac Muscle

- Cardiac muscle is only present within the heart
- It is a type of specialised striated muscle with the following properties:
  - It is **myogenic**, meaning that it can contract without external stimulation via nerves or hormones. This allows the heart to beat at its own regular intervals (the length of the intervals can be regulated by the nervous system and endocrine system)
  - It **does not tire or fatigue** so it can **contract (beat) continuously** throughout an individual's life
  - The cardiac muscle fibres form a **network** that spreads through the walls of the atria and ventricles
  - Cardiac muscle fibres are connected to each other via specialised **branched connections called intercalated discs**, this feature allows the contraction to spread **more quickly** across the chambers of the heart
  - There is a **large number of mitochondria** present in the muscle fibres. These are needed to provide the large quantity of **ATP** needed for continual contraction
  - Contractile myofibrils** are present in cardiac muscle in the same way that they are in skeletal fibres

Diagram to show the Structure of Cardiac Muscle Cells

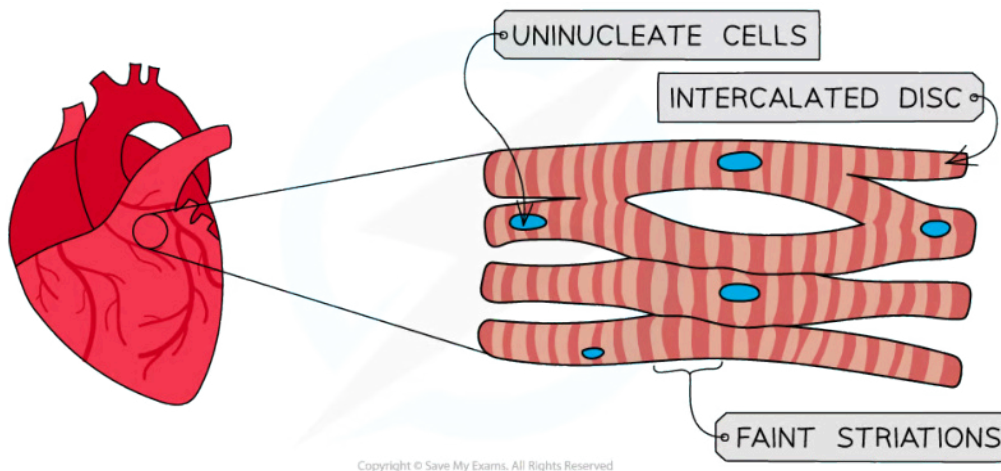

*The structure of cardiac muscle. There is only one nucleus per cell.*



Your notes

## Human Gamete Adaptations

### Sperm Cells

- Sperm and ova are examples of **specialised cells**, meaning that their **structure aids their function**
- Special features of sperm cells that relate to function include
  - A **haploid nucleus**, contained within a streamlined head, that can **fuse with an ovum** nucleus to form a diploid zygote
  - An **acrosome** containing **digestive**, or **hydrolytic**, **enzymes** to aid entry into the ovum through the **zona pellucida**
  - Many **mitochondria** (within the middle piece) for the **release of energy** to aid movement
  - A **flagellum** made of **protein microtubules** to aid movement

Diagram to show the Structure of a Sperm Cell

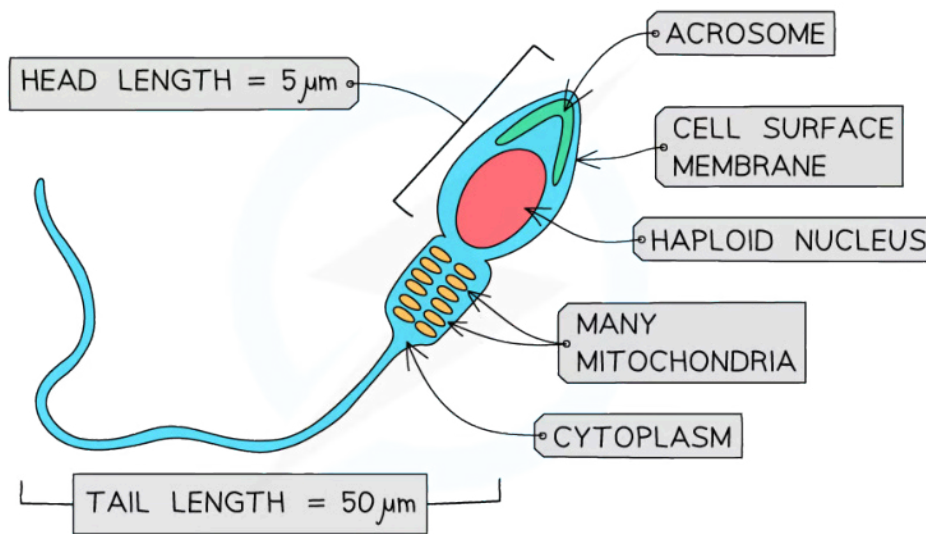

**Sperm cells are specialised to enable movement towards and entry into the ovum**

### Egg Cells

- Special features of ova that relate to function include
  - A **haploid nucleus** that can **fuse with a sperm cell** nucleus to form a diploid zygote
    - The final stage of meiosis is only completed after **fertilisation**
  - A surrounding jelly layer, or **zona pellucida**, that can harden to **prevent polyspermy** (when the ovum is penetrated by more than one sperm, this can affect embryo development)
  - **Follicle cells** which **nourish** and **protect** the ova
  - A series of **vesicles**, or **cortical granules**, containing **digestive enzymes** that are released into the zona pellucida to prevent polyspermy
  - A **cytoplasm** rich in **nutrients** for the **developing embryo** after fertilisation

Diagram to show the Structure of an Egg Cell



Your notes

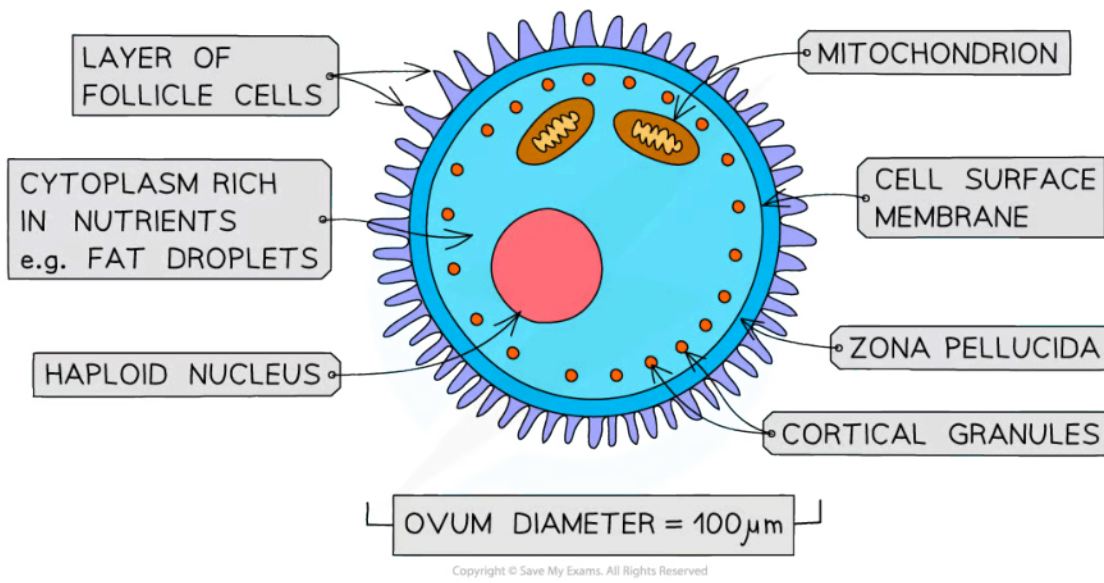

***Ova are specialised to prevent polyspermy and aid development of the embryo***